

**iXtrack A - B - C**  
**HSS, HSA, HBWP Booms**



# **iXtrack: Ready For a New iXperience**





# Every Crop Deserves the Best Care

Kverneland Crop Care believes that technology makes a better future. We develop intelligent solutions for a better harvest and to increase crop yields, because every crop deserves the best care. Our smart solutions help the farmers work in an easier and more profitable way.

Kverneland Group is a leading international company developing, producing and distributing agricultural machinery and services, with a long history based on a clear vision: listen to the farmers and make their work easier.

Today Kverneland Group, part of Kubota Corporation from Japan, has production sites in Norway, Denmark, Germany, France, The Netherlands, Italy, Russia and China. The company has Sales Companies in 17 countries and exports to another 60 countries worldwide.





**Field sprayers for farmers  
who protect their crops with  
less chemicals.**

For modern farmers optimal spraying means to protect their crops against diseases, plagues and weeds with as few chemicals as possible. We want enough food for the world, with lower impact on the environment. Kverneland field sprayers enable precision farming and spraying at the right moment, on the right spot.

For the farmer, higher yields, lower costs and less waste.



**Kverneland iXtrack**

**Are You Ready for a New iXperience?**







The iXtrack sprayer range is developed with big focus on operator comfort and environmental protection. The wide model range gives you all the opportunities to select the right model for your needs. It has a low centre of gravity and compact dimensions for higher working speeds and easy transportation on the road. The iXtrack is also available with ISOBUS Intelligence for even more customer benefits.



# Kverneland iXtrack A and B Make Your Choice!



iXtrack A is available in 2400 or 2800 litre tank with HSS 18 up to 30 metre steel booms.



Tank volumes of 2400, 2800 and 3600 litres are available on iXtrack B in combination with HSS 18 up to 36 metre steel booms or HSA 24 up to 33 metre aluminium booms.

## Easy hitching, easy following



### Low linkage drawbar

The design of this low linkage rigid drawbar for iXtrack A and B together with the PTO shaft allows you to have a very narrow turning radius.



### Low linkage drawbar with HydroFlex suspension

This low linkage drawbar for iXtrack B is adjustable in length and equipped with an adjustable pulling eye. The HydroFlex drawbar suspension provides you excellent driving comfort especially at higher speeds.

### TwinFlex axle suspension (iXtrack B)

The two horizontally mounted springs ensure you only small height variations aiding boom stability and constant nozzle height. It is a dynamic system: stiff suspension with full tank and smooth suspension with an empty tank.

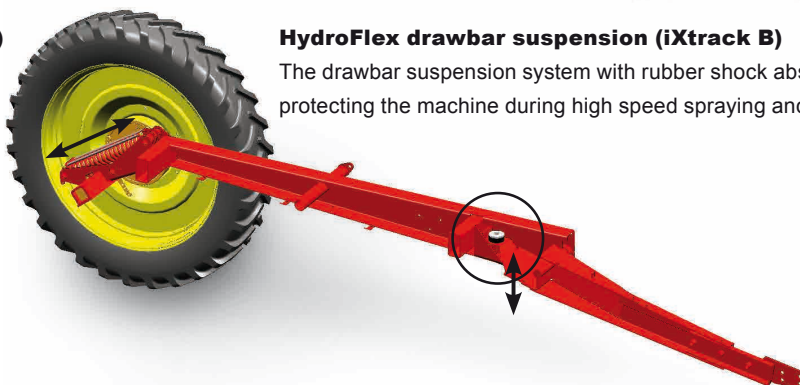

### HydroFlex drawbar suspension (iXtrack B)

The drawbar suspension system with rubber shock absorbers is protecting the machine during high speed spraying and transport.



## Wheel axle options to full fill your requirements



Adjustable axle (iXtrack A)



Adjustable suspended axle (iXtrack B)



Adjustable suspended steering axle (iXtrack B)

- Adjustable axle, sliding 1.60 - 2.10m
- Adjustable suspended axle, sliding 1.60 - 2.10m (TwinFlex suspension)
- Adjustable suspended steering axle, sliding 1.80 - 2.10m (TwinFlex suspension and Autotrac steering)

The track width for the adjustable and adjustable suspended axle is adjustable in steps of 5 cm. For the adjustable suspended steering axle the track width can be adjusted in steps of 10 cm. All wheel axles can receive hydraulic brakes as an option.

### Autotrac steering axle system

The Autotrac computer assisted steering axle provides you track following for minimal crop damage. It ensures a smooth reaction of the boom when turning and has an automatic or manual mode to bring the sprayer back into the track when crabbing.

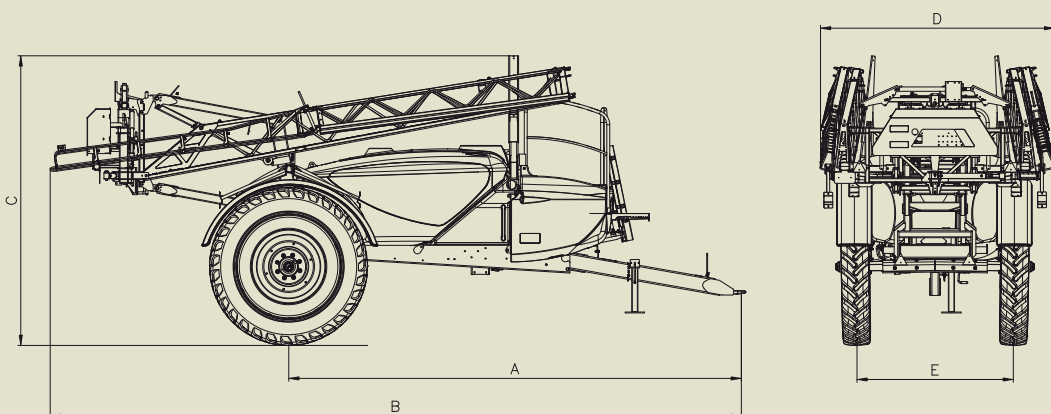

Model	iXtrack A	iXtrack B
<b>Boom</b>	<b>HSS</b>	<b>HSS/HSA</b>
<b>A</b> Pulling eye - wheel axle (m)	5.07	5.20 - 5.40
<b>B</b> Transport length (m)	7.39 - 7.92	7.42 - 8.41
<b>C</b> Transport height (m)	3.65 - 3.80	3.65 - 3.99
<b>D</b> Transport width (m)	2.55	2.55
<b>E</b> Track width (m)	1.60 - 2.10	1.60 - 2.10





## Kverneland iXtrack C

# The Perfect Model for Your Needs!



iXtrack C offers tank volumes of 3000, 4000 and 5000 litres in combination with HSS 18 up to 40 metre steel booms or HSA 24 up to 33 metre aluminium booms. The third available boom is the HBWP boom with a working width of 45 metres.

## Easy hitching, easy following



### Low linkage drawbar with HydroFlex suspension

This low linkage drawbar is adjustable in length and equipped with an adjustable pulling eye. The HydroFlex drawbar suspension provides you excellent driving comfort especially at higher speeds.

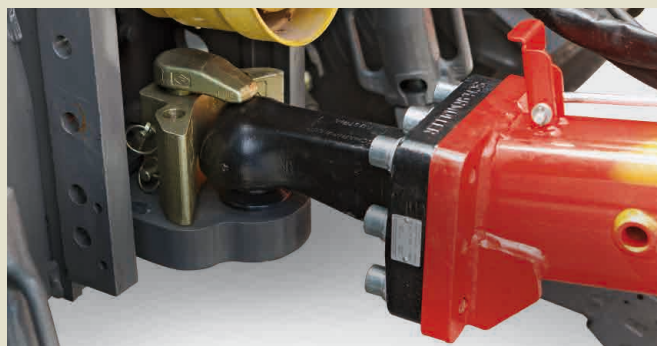

A pulling eye of  $\varnothing$  40/50mm for low or top linkage or ball coupling  $\varnothing$  80mm for safe and firm hitching available.



The low or top linkage drawbar with steering (unsuspended)



The low or top linkage drawbar with Hydroflex suspension and integrated pumps provides maximum ground clearance and well protected pumps.



## Select your wheel axle!



Adjustable suspended axle (iXtrack C30/C40)



Suspended axle (iXtrack C30/C40/C50)



Suspended steering axle (iXtrack C30/C40/C50/C60)

- Adjustable suspended axle, sliding 1.75 - 2.25m (40 km/h, TwinFlex suspension)
- Suspended axle: track adjustment by rims 1.80 - 2.25m (40 km/h, TwinFlex suspension)
- Suspended steering axle: track adjustment by rims 1.80 - 2.25m (40 km/h, TwinFlex suspension, Autotrac steering)

All wheel axles can receive hydraulic or pneumatic brakes as an option.

### Autotrac steering axle system

The Autotrac computer assisted steering axle provides you track following for minimal crop damage. It ensures a smooth reaction of the boom when turning and has an automatic or manual mode to bring the sprayer back into the track when crabbing.



### TwinFlex axle suspension

The iXtrack C is standard equipped with a hydraulic suspension system to ensure smooth suspension, but only small height variations aiding boom stability and constant nozzle height. It is a dynamic system: stiff suspension with full tank and smooth suspension with an empty tank.

### HydroFlex drawbar suspension

The drawbar suspension system with rubber shock absorbers is protecting the machine during high speed spraying and transport.

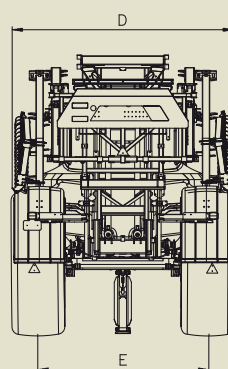
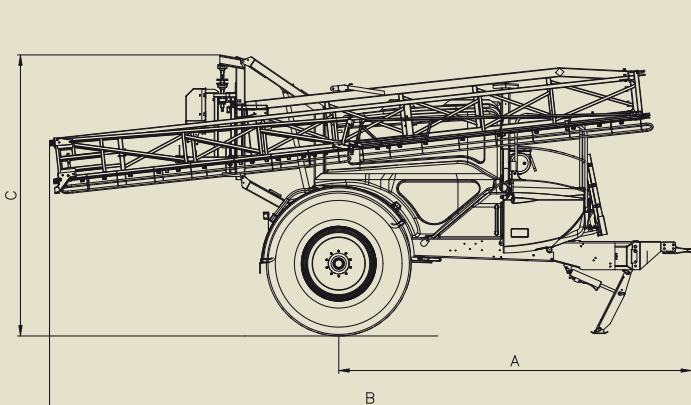

Model	iXtrack C	
	HSS/HSA	HBWP
<b>A</b> Pulling eye - wheel axle (m)	4.73 - 4.93	4.73 - 4.93
<b>B</b> Transport length (m)	7.39 - 8.10	8.78
<b>C</b> Transport height (m)	3.65 - 3.99	3.99
<b>D</b> Transport width (m)	2.55	2.99
<b>E</b> Track width (m)	1.80 - 2.25	1.80 - 2.25



# Easy Set Control Panel Leads You in the Right Direction

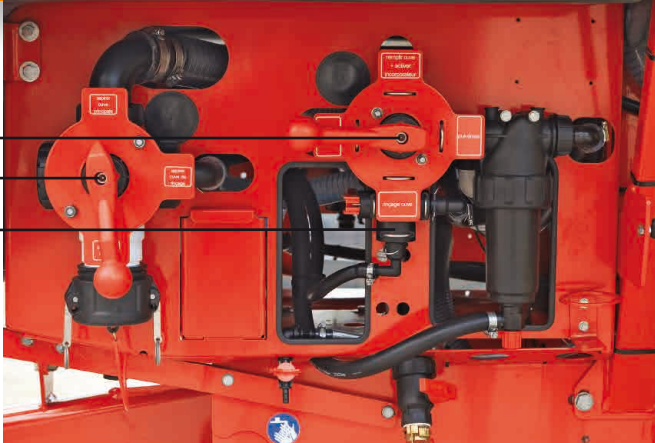

### Three extra pressure valves:

Functions: tank cleaning, external cleaning, pump out connection

### Four-Position pressure valve:

Position: filling main tank, spraying, additional functions, turbo agitation

### Three-Position suction valve:

Position: main tank, clean water tank, suction hose



### Easy Set control panel

The Easy Set control panel makes life easy by its intuitive operation.

The controls are separated in a suction and pressure side.

The valves are well protected behind the cover: this keeps your operational area free of dirt and chemicals.

## iXflow Spray Line Recirculation Fast, Direct Nozzle Control

**iXflow is our sophisticated spray line recirculation system with pneumatic nozzle control. Available on the iXtrack trailed sprayer range this combination creates a robust and fast-reacting spraying system, better suited to higher spraying speeds and automatic functions with GPS. Using reliable and proven components, for example the pump-PTO driven Wabco air compressor, ensures durability in high capacity, high output situations.**

Our circulation system ensures the spray liquid is always flowing through the sprayer, avoiding dead ends. But there is more.

Modern sprayers are often equipped with GPS section control and a fast reacting system without any pressure drop becomes a genuine advantage. This is achieved by using direct nozzle control with smart dual-feed spray lines. When boom sections are closed the spray liquid circulates through the spray lines back to the tank.

When opening sections for spraying, iXflow immediately uses the return side to feed spray liquid back to the nozzles. This fills the boom from both sides, liquid and full pressure immediately available at every nozzle. During cleaning, this system rinses and reduces the amount of unused spray liquid returning to the tank.

### iXflow benefits at a glance:

- Air operated nozzles: immediate nozzle reaction for start/stop spraying with GPS section control.
- Continuous flow: no risk of sedimentation or settling in the spray lines, so nozzles are less likely to suffer blockages.
- Spray lines fed from both sides: pressure adjustment, even lower residue levels when cleaning.
- Compatible with iXclean Comfort and iXclean Pro.

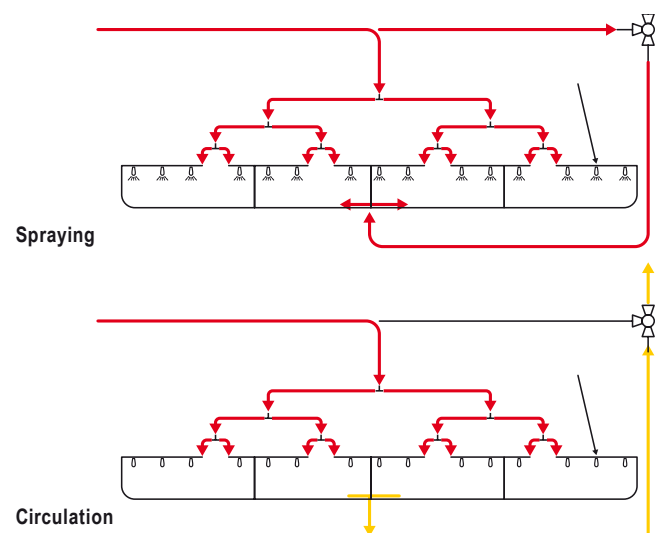



# iXclean Comfort and Pro Every Litre Counts



## iXclean Comfort

iXclean Comfort is a semi-automatic valve control system. The combination of an electrical level indicator and suction valve provides operator comfort and accuracy; automatic filling stops when the programmed level is reached, and remote control of all ENFO rinsing and priming functions are carried out from the cab! Simply prime the spray lines before you start and rinse them afterwards or even during an unexpected weather break, without having to leave the cab! ENFO is included as part of the standard specification of all Kverneland sprayers.



## iXclean Pro

Advanced solutions come from iXclean Pro, with fully automatic, electric valve management on ISOBUS sprayers. It means all functions can be controlled from the cab. Switching between filling, agitation, spraying, diluting, priming, rinsing and tank cleaning, is extremely easy: just push the button! In addition to auto filling, iXclean Pro offers also a fully automatic multi-step rinsing and cleaning program for the entire sprayer. Pushing one button a comprehensive cleaning process, including all lines starts. It takes just a few minutes and uses minimal amounts of clean water. It is so thorough, that residue levels after automated cleaning, are below 1%. iXclean Pro for filling or cleaning: making every litre count!

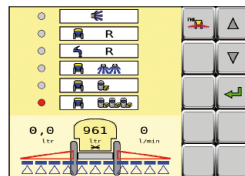

iXclean Pro screen  
IsoMatch Tellus GO /  
IsoMatch Tellus PRO



## We care about your crop!

### Environmental Focus: ENFO priming and rinsing system is standard on all our spray computers

This smart technology optimises filling and cleaning of the spray lines. Accurate application, no waste of chemicals and saving water are the benefits for you and your environment.



**Automatic Priming of spray lines:** before spraying starts the spray lines are filled with chemicals exactly up to the nozzle by automatic section shut off. This means no waste of chemicals and accurate application from the start of spraying.

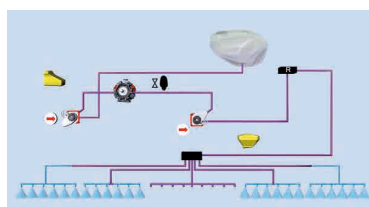

**Automatic Rinsing of spray lines:** after finishing or interruption, pesticides are automatically flushed out of the spray lines. This means using up to the last litre of mixture and rinsing the spray lines with a minimum of clean water consumption.

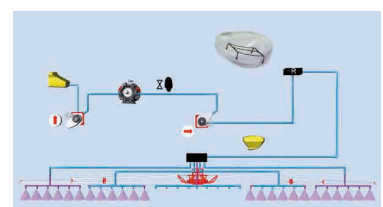



Easy Access

# iXtrack Offers You Easy Access



The iXtrack offers a generous and safe platform giving access to the man hole by means of a sliding aluminium ladder.



Easy access to filters, pumps, electrical and hydraulic circuits for easy maintenance.



The covers are giving easy access to the control panel and operator functions. Special attention has been put on service friendliness by easy access and quick-fit hose connections.



## Storage net

A storage net is integrated in the left side cover allowing you to keep your safety and cleaning equipment or tools with you on the sprayer.

## Chemical inductor

The chemical inductor is integrated between the main tank and the Easy Set control panel for easy access.

It is now also standard equipped with a strong powder nozzle which injects liquid under high pressure directly onto the bottom of the chemical inductor. Big quantities of powder and difficult mixtures are injected without any problem within seconds.





## Easy Operation

# Filling, Agitating and Cleaning is Easy and Safe



### Chemical inductor

The chemical inductor with a capacity of 42 litres allows you to mix chemicals safely. Equipped with a circular rinsing system and a waterproof cover, it can be rinsed safely with closed cover.

The rotating rinsing nozzle ensures powerful and efficient cleaning of the chemical containers. Positioned at the corner of the inductor, even very big containers can be positioned easily for cleaning!



### Clean water tank

The 360 litre clean water tank is equipped with a level indicator. It can be filled via the large opening on the clean water tank as well as by the standard external connection on the Easy Set control panel.

### External washing (optional):

A cleaning kit with a 15 metre hose and a brush, connected to the pressure side of the pump, allows pre-cleaning of the sprayer in the field, using water from the clean water tank.



### Agitation system

The unique return agitation system, standard on all iXtrack sprayers, keeps the mixture homogeneous during operation and can be easily switched off in case of foam risk or a nearly empty tank. The powerful high pressure agitation with injector nozzles, standard on all iXtrack C sprayers (option for iXtrack A and B) guarantees powerful mixing which you can activate after filling or a long break.





## Easy Operation

# Everything at the Right Place



### Transparent suction filter with 2 way valve:

The unique transparent bowl provides direct view on the dirt degree of the suction filter without dismounting! A valve at the bottom allows emptying the filter content before removing the bowl to avoid contamination of the hands with chemicals.



The self cleaning pressure filter prevents blocking via a continuous flow keeping the filter mesh clean.

The undissolved particles are returned into the tank until they are completely dispersed.

### The new silent piston diaphragm pumps

Depending on your situation you can select a pump from a wide range of pump capacities. Small fields and booms, low volume applications or high speed, wide booms and large tank size, pumps with capacities from 200, 250, 400 up to 500 l/m are available. Depending of the flow rate needed for spraying, the double pumps can be delivered with connected or separate flow circuits. With separate circuits, one part of the flow is used for a higher filling speed and more powerful agitation. Advantages of our pumps are:

- Continuous pressure of 15 bar, maximum 20 bar
- Liquid fertiliser resistant
- Compact, small residual quantities of chemicals
- Linear steady state characteristics for precise regulation



### Filling via the 3" suction hose

External sources water is filtered first by the filter on the hose and then by the suction filter. In parallel you can use the chemical inductor to add and premix chemicals.



### Hydrant filling and pump out connection

Optional available is a hydrant fill connection with anti return valve for direct filling under pressure. The optional pump out connection can be used to restore liquid fertiliser.



### Electrical level indicator

The optional electrical level indicator provides the actual tank volume to the spraying computer, as well as via the external display on the EasySet control panel. iXclean Comfort and iXclean Pro include the electrical level indicator as standard equipment.



# FMC, Starguide IV

## Make Spraying Easy



### FlowMate Control FMC:

- Basic spray computer
- Extremely simple to operate
- Very compact by integration of all spraying and hydraulic functions
- Controlling the ENFO functions
- Integrated nozzle advice
- Memory for 25 different fields

### Starguide IV: Automatic GPS section control and guidance by D-GPS

Those who have used it will never go back. Starguide IV will change your spraying days forever: spray around the headland and the Starguide IV will control the spray sections automatically as you cover the remainder of the field.

### The Starguide IV enables you:

- Spraying in the dark
- Accurate spraying by full overlap control
- Increased operator comfort
- Cost savings by reduced overlap

In addition the Starguide IV also includes the following features:

- Easy to operate, intuitive 5.7" colour touch screen

- Integral light bar guidance system
- Field view with covered areas and overlap
- Single and double overlap in different colours
- GPS status warnings
- USB slot for data export in different formats
- RXA-30 antenna

Starguide IV is easy to operate: after spraying a field boundary the overlap and headland management are controlled for the rest of the field!



## IsoMatch Tellus GO

**The IsoMatch Tellus GO is a Universal ISOBUS Terminal. This multifunctional one-screen terminal has been developed for fast and simple control of any ISOBUS implement, giving the farmer a 'custom made' experience as it suits all needs for simple and efficient handling of farming machinery and tasks.**

- Multifunctional one-screen Terminal with 7" touch Screen
- Fast and simple implement control via touch screen, rotary button and hard keys or additional joystick
- Display of all relevant machine status information like speed, working width and application rate
- Application includes Manual Guidance, coverage logs and documentation of task data like: working time, machine specific total: i.e. total hectares, kg's of fertiliser, litres of spray liquid, number of bales, etc. and additional details such as farm: farm, operator, field, machine, etc
- Support for external variable rate systems
- 2x USB 2.0 connections
- Camera input
- Diagnostic and service info

### Additional functionality via the GEOCONTROL application:

- IsoMatch GEO-SC: Automatic Section Control
- IsoMatch GEO-VR: Automatic Variable Rate via prescription maps



The IsoMatch Tellus GO can be used in combination with the switchbox to operate spray and boom functions or with the IsoMatch Grip for easy machine control and efficient farming.

## IsoMatch Tellus PRO

# The Next Generation Terminal!



**The IsoMatch Tellus PRO has the capability to view and operate 2 different ISOBUS interfaces at once. This allows direct control of 2 implements at the same time, use IsoMatch GEOCONTROL or display a camera view, without switching screens.**

- Two ISOBUS interface screen with glossy look
- Large 12.1" colour touch screen
- Intuitive operation
- Basic DOC registration program to save operational information directly to USB
- Four USB slots for quick data exchange (e.g. ISO-XML field maps, PDF), wireless USB stick or USB to serial cable for additional sensors
- Built in PDF reader: store and read any PDF document such as operator manuals
- RS232 connection for GPS receivers or sensors
- Internet connection via a wireless USB stick or router
- Integrated web browser

The IsoMatch Tellus PRO can be used in combination with the switchbox to operate spray and boom functions or with the IsoMatch Grip for easy machine control and efficient farming.

## IsoMatch GEOCONTROL Brings Clear Benefits

**IsoMatch GEOCONTROL** is an additional software application within the IsoMatch Tellus that helps you to control all ISOBUS compatible Kverneland Group machines such as sprayers, spreaders and seeders! Combined with a GPS receiver it fulfils the future needs in terms of easy, smart and efficient farming. Easy operation and driver comfort due to the automatic implement control. You can stay focused on driving, while IsoMatch GEOCONTROL lightens the workload. Reduced overlap and redundant tracks results in increased quality of work and efficiency by cost savings in time, fuel, fertiliser, pesticides and seeds.

### Section control

Automatic switching on and off implement sections on headlands, boundaries and already covered areas to minimise overlap.

### Variable rate control

Automatically adjusts the implement application rate based on input from the field prescription or crop sensors.

### Documentation

Saves all operational job data and field maps for exchange via USB to farm management information systems.

### Manual guidance

- Advised driving position using guidance lines (straight, curved or combined) in the field and on headlands.
- Extendable using the optional IsoMatch InLine light bar, to place guidance in line of sight.
- Smart boundary recording: independent from the working width, even without any implement corrected.
- Boundary shrinking: create new inner boundaries by setting the desired width of the headland.
- Manual guidance for all operations, includes non-electric or non-ISOBUS implements. e.g. cultivators, mowers, tedders etc.
- Headland control: create headland boundary and headland guidance lines.



### ISOMATCH GEOCONTROL

- Easy and comfort of operation, due to not having to manually switch on or off sections or change the application rate. You can focus 100% on the driving in the field.
- More efficient work and avoiding overlap leads to cost savings of 5-10% on e.g. fertiliser, pesticides and seed. Better growing conditions and the increased yield.
- With IsoMatch GEOCONTROL, working at night time becomes very easy. IsoMatch GEOCONTROL reduces the workload considerably.



# Boom Guide, ErgoDrive and Grip Make Your Life Easy



## IsoMatch Grip

### Control at your finger tips!

- In combination with IsoMatch Tellus PRO or IsoMatch Tellus GO
- Up till 44 functions divided over 4 modes can be programmed to cover the spraying needs

## ErgoDrive

ErgoDrive headland management system assists you on the head land turns. Activated by simply switching Spraying ON or OFF the ErgoDrive controls all the necessary actions, while you can focus on driving safely. Four functions easy under one switch!

### Four functions at the same time:

- Spraying off
- Levelling spray boom
- Lifting boom to a set headland height
- Activating Autotractor steering system

### Maintain your boom height!

Boom Guide is our automatic boom height control system that helps you to maintain your chosen spraying height.

### Boom Guide Comfort

The two ultrasonic sensors on the boom can control the spray height via the central slope correction and boom lift functions. This cost-effective system is suited to gentle slopes, uneven crop conditions and lower driving speeds.

### Boom Guide Pro

This advanced system uses three ultrasonic sensors to control left- and right-hand boom sections independently for the ultimate guidance in the most challenging field conditions.

It can deliver positive and negative lateral movement on each side of the boom to follow the contours in every condition!

### Boom Guide ProActive

The system proactively reacts on boom movement and controls both the central and independent slope corrections, as well as boom lift functions to guide the boom over the crop canopy, soil surface or a combination of both modes.



### Advantages of Boom Guide:

- Less drift: more constant and correct nozzle height
- Increased capacity: allows faster spraying speeds, also in the dark
- Driver comfort: less fatigue with easier focus on spraying
- Integrated ErgoDrive functionality: automatic lifting and lowering on headland turns
- Crop, Soil or Hybrid mode selection: closely follow the top of a closed canopy, follow the soil in an uneven, open canopy or row crop situation or a combination of both situations
- Safe transport: ultrasonic sensor automatically fold with boom in its transport position
- ISOBUS compatible: easy plug and play operation with ISOBUS compatible (tractor) terminals

Boom Guide Comfort

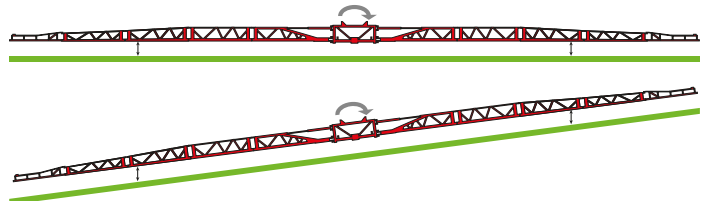

Boom Guide Pro

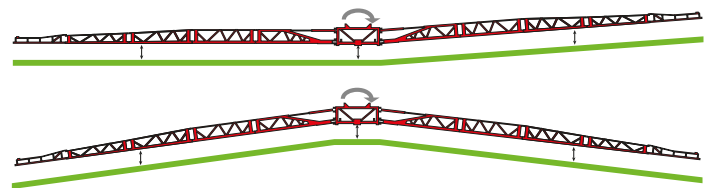

Boom Guide ProActive

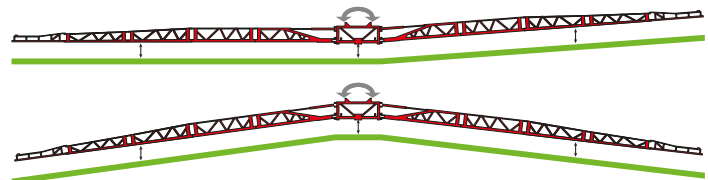

# iM FARMING

smart efficient easy **FARMING**



**iM FARMING makes mechanical work smarter, more efficient and simpler. The use of ISOBUS technology makes machinery easier to connect, operate, control and monitor.**

Maximum return from your investments, that is the core of Kverneland Group's iM FARMING solutions. iM FARMING describes and presents our offering on ISOBUS machines and solutions for electronic steering of implements. All aimed at giving an insight into the benefits and efficiency of our extensive offering, adapted to your requirements that is what you can expect from Kverneland Group. Now and in the future. Intended to make life easier for farmers.

## ► Precision Spraying

Do you also want to spray a less as possible, at the right moment, at the right spot? That's why we have developed IsoMatch GEOCONTROL. This smart and modern technology prevents waste of expensive chemicals and ensures perfect alignment on the headlands and in the triangles. Overlap is a thing of the past, which not only saves on crop protection agents, it also ensures a more equal crop yield and quality. Each plant receives exactly the same amount of crop protection.

## ► ISOBUS compatible

For even more operator comfort we have some other features available on our sprayer range. Boom Guide is an ultrasonic boom height control system operating the boom lift, slope correction and independent slope correction cylinders. iXclean Pro is our full electrical valve management system where all the functions can be controlled from the operators seat.

- 100% ISOBUS compatible
- Minimise overlap
- Parcel registration and data storage
- Up to 10% saving on pesticides
- Automatic switching ON/OFF through IsoMatch GEOCONTROL





**iM Ready**  
ISOBUS THAT'S WHAT I CALL SMART WORKING

**iM inControl**  
ONE TERMINAL TO CONTROL ALL OF MY ISOBUS MACHINES

**iM Global**  
WITH GPS IT'S SIMPLE AND MORE EFFICIENT

**iM Intelligent**  
EASY, I JUST USE INTELLIGENT MACHINERY

## IsoMatch GEOCONTROL and SPRAYERCONTROL

Would you like to have some clear benefits? You just have to buy the IsoMatch Tellus Terminal, a license and one of our ISOBUS compatible sprayers. Save 5% to 10% on your spraying costs and control and optimise your spraying process with IsoMatch GEOCONTROL. Working at night? No worries, be at the forefront of environmental constraints. It is now possible with our applications!



**iXtrack**



**iXter**



**Ikarus S**



*IsoMatch InLine*



*Manual guidance*



*Section control*



*Variable rate control*



*Documentation*

### ► IsoMatch GEOCONTROL

Once you have an IsoMatch Tellus Terminal you can simply unlock the IsoMatch GEOCONTROL application (after you have purchased a license key) and you get access to all precision farming applications: automatic switching on and off implement sections, variable rate control, manual guidance and easy exchange of data between the IsoMatch Tellus and your PC. To get familiar and convince yourself about the customer benefits of IsoMatch GEOCONTROL you are entitled to 25 hours free of use of the application, before purchasing a license. No doubt for us, you will quickly become an enthusiastic follower of this new technology!



**IsoMatch Global**



**IsoMatch Eye**

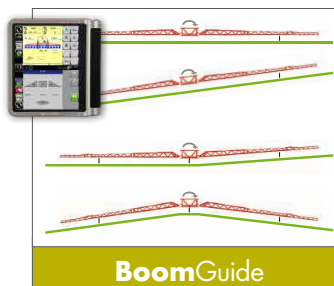

**BoomGuide**



**iXcleanPro**





## HSS Boom

# The Professional and Compact Steel Bo



The HSS boom range is designed for professional use. Its triangular construction provides perfect integration of the stainless steel spray lines, nozzles and nozzle holders and the optimal hose routing where all is well protected. The special HSS profile combines a minimum of weight with maximum strength and stability. Computer assisted design, use of laboratory and field tests, special hardened Domex steel contribute to the legendary reputation of this long lasting heavy duty high quality booms. Working widths from 18 up to even 40 metres with a variation in different section lengths offer you the sprayer adapted to your demands!

The clever tank design greatly contributes to the sprayers low centre of gravity. Short turning on the head land is possible even in hilly conditions. The parallelogram can be raised or lowered with two hydraulic cylinders with nitrogen dampers. A high clearance of 2.65m from the nozzle to the ground can be achieved!

HSS boom (m)	Spraying width*		# of sections
	Symmetric folding (m)	Asymmetric folding (m)	
18	12	15	5/7/9
20	12	16	5/7
21	12	16,5	5/7
24	12	18	5/7/9
27	15	21	5/7/9
28	15	21,5	7/9
30	15	22,5	9
27 <sup>1)</sup>	21/12	24	5/7/9
28 <sup>1)</sup>	21/12	24,5	7/9
30 <sup>1)</sup>	21/12	25,5	9
32 <sup>1)</sup>	28	30	9/11
33 <sup>1)</sup>	28	30,5	9/11
36 <sup>1)</sup>	28	32	9/11
39 <sup>1)</sup>	28	33,5	13
40 <sup>1)</sup>	28	34	9/11/13

\* Indicated spraying width may depend on selected number of sections and their dividing  
<sup>1)</sup> 3-part folded booms





# om Range



## Balancing system with two pivoting points

- The boom freely balances around the top pendulum and can also pivot around a central pivoting point.
- The boom automatically adapts to hilly conditions and remains stable during turning



## Transport

Narrow roads, bridges, hedges and trees are no issue for the HSS booms. All booms have a transport width of 2.55m. And the overall height is below 4m. A compact design with clear and safe visibility.



A hydraulic cylinder between the first and second boom part ensures that the second boom part folds away when the spray boom hits an obstacle in the field like a tree or electricity pole. The hydraulic break away avoids damage to the complete spray boom. The safety break away device is standard equipped on the HSS 32-40 metre spray boom range.



**HSA Boom**

# The High Tech Aluminium Boom



Efficient protection of the nozzle holders within the bottom profile of the boom. This profile is designed for easy cleaning. With no sharp angles, no liquid and residues can be trapped. The anodised surface protects against corrosion and scratches.

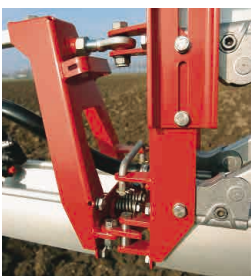

### 3D safety tipend

3 dimensional safety tipend with automatic reset. A locking system with latches makes yaw impossible.

Spraying width*			
HSA boom (m)	Symmetric folding (m)	Asymmetric folding (m)	# of sections
24	12	18	5/7/9
27	15	21	7/9
28	15	21,5	7/9
30	15	22,5	7/9/11
32	17	24,5	9/11
33	17	25	9/11

\* Indicated spraying width may depend on selected number of sections and their dividing







### 5 Year Warranty

Aluminium bonding instead of welding provides a weight saving and remarkable strength. Developed in close cooperation with aluminium specialist Norsk Hydro, this patented aerospace technology has consistently proven itself in the field over the past years. As a result of these experiences and our full believe in the strength of the design, Kverneland offers 5 year warranty on the bonding and clamping of the boom.



### Pendulum system

The efficient HSA boom pendulum system is guided by two heavy bearings. The locking of the pendulum system is needed for folding in and for spraying with asymmetric folding.



### Parallelogram

The parallelogram on the iXtrack sprayer is suspended via two nitrogen dampers. The hydraulic cylinders can be locked mechanically or automatically during transport.

### Transport

The iXtrack in combination with the HSA boom offers you a compact sprayer for easy driving, even on narrow roads.

Folding or unfolding with two integrated cylinders gives you total control of the boom movement. When the boom is folded out, the hydraulic cylinder rod is in. This gives added strength and protection to the cylinder and a rigid spray boom.





## HBWP Boom

# Go Wide with Perfect Guiding and Stability



Perfect boom guiding in hilly or flatland position through a professional double trapezium balancing system. In flatland position the boom is perfectly levelled out and compensates a wrong position of the sprayer compared to the field shape. In hilly conditions the HBWP boom is following automatically the inclination of the sprayer.

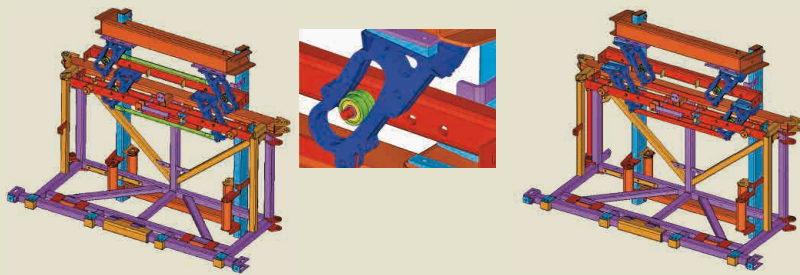

The anti yaw system provides you independent suspension left/right and is eliminating boom movements created by accelerating and braking.

Spraying width*		
HBWP boom (m)	symmetric folding (m)	# of sections
45	29	13

\* Indicated spraying width may depend on selected number of sections and their dividing



The strong parallelogram system with two lifting cylinders gives an optimum spraying height and no torsion whilst folding the boom in and out.





# The Crop Care Factory

## For Customers Benefits

High tech field sprayers and fertiliser spreaders are produced and developed at the Kverneland Group Crop Care competence centre in Nieuw-Vennep, The Netherlands. The Crop Care products are developed with high focus on quality and customer comfort.

### Sprayer Test Hall for Top Quality!



A highly qualified team of sprayer specialists tests every sprayer leaving the factory, in our own test hall to meet the latest environmental regulations. Our testers are certified for all of the following test procedures.



**NSTS:** National Sprayer Testing Scheme is the relevant authority in UK for sprayer homologation.



**JKI:** Official homologation for Germany, delivered by the Federal Biological Research Centre of Germany, now JKI Institute.



**SKL:** Official homologation for Benelux, delivered by the SKL foundation for agricultural machinery in Wageningen.



**NY:** Official homologation for Norway, delivered by the Norwegian Food and Safety Authority.



**ENTAM:** Homologation is in process. ENTAM is the European Network for Testing Agricultural Machines. JKI of Germany and Cemagref of France are among others, official members of ENTAM.

### High tech aluminium boom assembly hall



The high tech aluminium boom production location is a closed and ultra clean environment with climate control and pressurisation to guarantee ideal conditions and top quality for the gluing procedure of our famous aluminium booms. Focus is given in all production processes to trainings and certifications of people to ensure a high quality standard of Crop Care products.



### In-house competence centre for electronic controls

Innovation is the core business of Kverneland Group Mechatronics, competence centre for electronic controls for agriculture implements, within Kverneland Group. With a professional team of 70 people, (of which are 45 R&D engineers), Kverneland Group Mechatronics is a global leader in the optimisation of agriculture (implement) processes using software, hardware and mechatronic solutions.

# Kverneland iXtrack

## Technical Specifications

iXtrack	A24	A28	B24	B28	B36	C30	C40	C50
<b>1. Tank size</b>								
Nominal tank capacity (l)	2400	2800	2400	2800	3600	3000	4000	5000
Maximum main tank capacity (l)	2650	3050	2650	3050	3800	3297	4230	5378
Clean water tank (l)	360	360	360	360	360	360	360	360
Hand wash tank (l)	15	15	15	15	15	15	15	15
<b>2. Empty weight (total machine incl. boom)</b>								
... with HSS 18m	2755 kg	2785 kg	3175 kg	3205 kg	3235 kg	3985 kg	4235 kg	4285 kg
... with HSS 20m	2810 kg	2840 kg	3230 kg	3260 kg	3290 kg	4030 kg	4280 kg	4330 kg
... with HSS 21m	2820 kg	2850 kg	3240 kg	3270 kg	3305 kg	4040 kg	4290 kg	4340 kg
... with HSS 24m	2860 kg	2890 kg	3290 kg	3310 kg	3340 kg	4080 kg	4330 kg	4380 kg
... with HSS 27m	3050 kg	3080 kg	3510 kg	3500 kg	3530 kg	4310 kg	4560 kg	4610 kg
... with HSS 28m	3070 kg	3100 kg	3530 kg	3520 kg	3550 kg	4330 kg	4580 kg	4630 kg
... with HSS 30m	3090 kg	3120 kg	3550 kg	3550 kg	3580 kg	4350 kg	4600 kg	4650 kg
... with HSS 32m	-	-	-	3915 kg	3945 kg	4645 kg	4895 kg	4945 kg
... with HSS 36m	-	-	-	3950 kg	3980 kg	4680 kg	4930 kg	4980 kg
... with HSS 39m	-	-	-	-	-	4780 kg	5020 kg	5070 kg
... with HSS 40m	-	-	-	-	-	4800 kg	5040 kg	5100 kg
... with HSA 24m	-	-	-	3430 kg	3460 kg	4150 kg	4400 kg	4450 kg
... with HSA 27m	-	-	-	3460 kg	3490 kg	4200 kg	4450 kg	4500 kg
... with HSA 28m	-	-	-	3470 kg	3500 kg	4210 kg	4460 kg	4510 kg
... with HSA 30m	-	-	-	3490 kg	3520 kg	4250 kg	4500 kg	4550 kg
... with HSA 32m	-	-	-	3560 kg	3590 kg	4290 kg	4540 kg	4590 kg
... with HSA 33m	-	-	-	3570 kg	3600 kg	4300 kg	4550 kg	4600 kg
... with HBWP 45m	-	-	-	-	-	-	5310 kg	5360 kg
<b>3. Drawbar</b>								
Low linkage rigid (including pulling eye Ø50mm)	Standard			▲ <sup>1</sup>			-	
Low linkage with HydroFlex suspension	-			▲ <sup>2</sup>			▲ <sup>1</sup>	
Low or Top linkage (integrated pumps) with HydroFlex suspension	-			-			▲ <sup>2</sup>	
Low or Top linkage steering (integrated pumps), unsuspended	-			-			▲ <sup>3</sup>	-
<b>4. Pulling eye</b>								
Pulling eye Ø 40mm	-			▲ <sup>1</sup>			▲ <sup>1</sup>	
Pulling eye Ø 50mm	-			▲ <sup>2</sup>			▲ <sup>2</sup>	
Ball coupling Ø 80mm	-			▲ <sup>3</sup>			▲ <sup>3</sup>	
<b>5. Wheel axle</b>								
Adjustable axle: sliding 1.60 - 2.10m	▲ <sup>1</sup> Rigid			-			-	
Adjustable suspended axle: sliding 1.60 - 2.10m	-			▲ <sup>1</sup> TwinFlex suspension			-	
Adjustable suspended steering axle: sliding 1.80 - 2.10m	-			▲ <sup>2</sup> TwinFlex suspension, Autotrac steering			-	
Adjustable suspended axle: sliding 1.75 - 2.25m (40km/h)	-			-		▲ <sup>1</sup> TwinFlex hydraulic suspension	-	
Suspended axle: track adjustment by rims 1.80 - 2.25m (40km/h)	-			-		▲ <sup>2</sup> TwinFlex hydraulic suspension	-	
Suspended steering axle: track adjustment by rims 1.80 - 2.25m (40km/h)	-			-		▲ <sup>3</sup> TwinFlex hydraulic suspension, Autotrac steering	-	
Hydraulic brake	●			●			▲ <sup>1</sup>	
Air brake	-			-			▲ <sup>2</sup>	
<b>6. Pumps</b>								
4 Piston-diaphragm pump 200 l/min	-		▲ <sup>1</sup>				▲ <sup>1</sup>	
4 Piston-diaphragm pump 250 l/min	-		▲ <sup>2</sup>				▲ <sup>2</sup>	
8 Piston-diaphragm pump 2x 200 l/min (separate or connected)	-		-	▲ <sup>3</sup>			▲ <sup>3</sup>	
8 Piston-diaphragm pump 2x 250 l/min (separate or connected)	-		-	▲ <sup>4</sup>			▲ <sup>4</sup>	
<b>7. Electronics</b>								
<b>7.1. Basic electronics incl. FMC control box</b>								
FMC 5, 7 or 9 sections for Hydro pack Basic (pre select hydraulics)	-		▲ <sup>1</sup>				▲ <sup>1</sup>	
FMC 5, 7 or 9 sections for Hydro pack Comfort (oil circuit hydraulics)	-		▲ <sup>2</sup>				▲ <sup>2</sup>	
<b>7.2. ISOBUS electronics excl. control box</b>								
FMA 5-15 sections for Hydro pack Comfort (oil circuit hydraulics)	-		-	▲ <sup>3</sup>			▲ <sup>3</sup>	
<b>7.2.1. ISOBUS controls for ISOBUS electronics</b>								
IsoMatch Tellus GO or PRO	-		-	▲ <sup>1</sup>			▲ <sup>1</sup>	
Switchbox (for IsoMatch Tellus or other ISOBUS tractor with VT terminal)	-		-	▲ <sup>2</sup>			▲ <sup>2</sup>	
IsoMatch Grip	-		-	●			●	
<b>8. Options (factory fitted)</b>								
Electrical level indicator	-		-	●			●	
iXclean Comfort (incl. electrical level indicator)	-		-	●			●	
iXclean Pro (incl. electrical level indicator, FMA electronics only)	-		-	●			●	
iXflow circulation system (only possible in combination with FMA)	-		-	●			●	
Boom Guide Comfort, Pro or ProActive (only possible in combination with IsoMatch Tellus GO or PRO)	-		-	●			●	
<b>9. Accessories (also loose available)</b>								
ErgoDrive headland management system (ISOBUS compatible)	-		-	●			●	
High pressure agitation	-		●				Standard	
Border or verge nozzle (manual or electrical)	-		●				●	
Mud guards (400-550-700mm)	-		●				●	
Protection curtain	-		●				●	
Hydrant filling connection	-		●				●	
Outside cleaner	-		●				●	
Spray gun	-		●				●	
Chemical inductor	-		●				●	
Clean cloth locker	-		●				●	
Suction hose 3"	-		●				●	
Non return valve set 3"	-		●				●	
4 LED boom lights	-		●				●	
Starguide IV GPS Section Control	-		● Available from 30 meter booms				● Available from 30 meter booms	
Tilt gyro module for Starguide IV	-		●				●	

▲<sup>1</sup> - ▲<sup>2</sup> - ▲<sup>3</sup> - ▲<sup>4</sup> = one of these choices must be selected    ▲ = must be selected, ● = option, free to select



Spray Booms	HSS 18-30	HSA 24-33	HSS 27-36	HSS 39-40	HBWP 45
<b>1. Basic boom functionality</b>					
Working width	18/20/21/24/27/28/30	24/27/28/30/32/33*	27/28/30/32/33/36	39/40	45
Material	Steel	Aluminium	Steel	Steel	Steel
Folding principle	Side folding	Side folding	Three-Part-Compact side folding	Three-Part-Compact side folding	Compact side folding
<b>2. Spray sections</b>					
Standard	5 / 5 / 5 / 7 / 7 / 7 / 9	7 / 7 / 7 / 9 / 9 / 9 / 9	7 / 7 / 9 / 9 / 9 / 9	13 / 11	13
Alternative 1 (two sections more than standard)	7 / 7 / 7 / 9 / 9 / 9 / -	9 / 9 / 9 / 11 / 11 / 11 / 11	9 / 9 / - / 11 / 11 / 11	- / 13	15
Alternative 2 (two sections less than standard)	- / - / - / 15 / 15 / -	5 / - / - / 17 / - / - / -	5 / - / - / - / - / -	- / 9	-
<b>3. Spray jets</b>					
Monojet	▲ <sup>1</sup>	▲ <sup>1</sup>	▲ <sup>1</sup>	▲ <sup>1</sup>	▲ <sup>1</sup>
Trijet	▲ <sup>2</sup>	▲ <sup>2</sup>	▲ <sup>2</sup>	▲ <sup>2</sup>	▲ <sup>2</sup>
Pentajet	▲ <sup>3</sup>	▲ <sup>3</sup>	▲ <sup>3</sup>	▲ <sup>3</sup>	▲ <sup>3</sup>
<b>4. Transport height</b>					
Transport height in average (depending on wheels)	3.30m	3.80m	3.60m	3.90m	3.99m
<b>5. Boom hydraulics</b>					
<b>Hydro package HSS/HSA Basic 1: pre select hydraulics:</b>					
1 SA tractor valve for parallelogram lift and 1 DA tractor valve needed for boom functions:					
- symmetric boom reduction	▲ <sup>1</sup>	▲ <sup>1</sup>	▲ <sup>1</sup>	▲ <sup>1</sup>	-
- slope correction					
- hydraulic locking					
<b>Hydro package HSS/HSA Comfort 1: oil circuit hydraulics:</b>					
1 DA tractor valve (or 1SA + free return) needed:					
- parallelogram lift	▲ <sup>2</sup>	▲ <sup>2</sup>	▲ <sup>2</sup>	▲ <sup>2</sup>	-
- symmetric boom reduction					
- slope correction					
- hydraulic locking					
<b>Hydro package HSS/HSA Comfort 2: oil circuit hydraulics:</b>					
1 DA tractor valve (or 1SA + free return) needed:					
- parallelogram lift	▲ <sup>3</sup>	▲ <sup>3</sup>	▲ <sup>3</sup>	▲ <sup>3</sup>	-
- symmetric & asymmetric boom reduction					
- slope correction					
- hydraulic locking					
<b>Hydro package HSS/HSA Comfort 3: oil circuit hydraulics:</b>					
1 DA tractor valve (or 1SA + free return) needed:					
- parallelogram lift	▲ <sup>4</sup>	▲ <sup>4</sup>	▲ <sup>4</sup>	▲ <sup>4</sup>	-
- symmetric & asymmetric boom reduction					
- slope correction					
- independent slope correction					
- hydraulic locking					
<b>Hydro package HBWP Comfort 1: oil circuit hydraulics:</b>					
1 DA tractor valve (or 1SA + free return) needed:					
- parallelogram lift	-	-	-	-	▲ <sup>1</sup>
- symmetric boom reduction					
- slope correction					
- hydraulic locking					
<b>Hydro package HBWP Comfort 2: oil circuit hydraulics:</b>					
1 DA tractor valve (or 1SA + free return) needed:					
- parallelogram lift	-	-	-	-	▲ <sup>2</sup>
- symmetric boom reduction					
- slope correction					
- independent slope correction					
- hydraulic locking					

Information provided in this brochure is made for general information purposes only and for worldwide circulation. Inaccuracies, errors or omissions may occur and the information may thus not constitute basis for any legal claim against Kverneland Group. Availability of models, specifications and optional equipment may differ from country to country. Please consult your local dealer. Kverneland Group reserves the right at any time to make changes to the design or specifications shown or described, to add or remove features, without any notice or obligations. Safety devices may have been removed from the machines for illustration purposes only, in order to better present functions of the machines. To avoid risk of injury, safety devices must never be removed. If removal of safety devices is necessary, e.g. for maintenance purposes, please contact proper assistance or supervision of a technical assistant.

© Kverneland Group Nieuw-Vennep BV



## Kverneland Group

**Kverneland Group is a leading international company developing, producing and distributing agricultural machinery and services.**

Strong focus on innovation allows us to provide a unique and broad product range with high quality. Kverneland Group offers an extensive package aimed at the professional farming community, covering the areas of soil preparation, seeding, forage and bale equipment, spreading, spraying and electronic solutions for agricultural tractors and machinery.



## Original Spare Parts

**Kverneland Group spare parts are designed to give reliable, safe and optimal machinery performance - whilst ensuring a low cost life-cycle. High quality standards are achieved by using innovative production methods and patented processes in all our production sites.**

Kverneland Group has a very professional network of partners to support you with service, technical knowledge and genuine parts. To assist our partners, we provide high quality spare parts and an efficient spare parts distribution worldwide.



**Watch us on YouTube**  
[www.youtube.com/kvernelandgrp](http://www.youtube.com/kvernelandgrp)



**Like us on facebook**  
[www.facebook.com/KvernelandGroup](http://www.facebook.com/KvernelandGroup)  
[www.facebook.com/iMFarming](http://www.facebook.com/iMFarming)



**Follow us on Twitter**  
[#KvernelandGroup](https://twitter.com/KvernelandGroup)  
[#iM\\_Farming](https://twitter.com/iM_Farming)

